

**1A output current, fixed 5V<sup>(\*)</sup> Output voltage, Boost Converter with 2.75A Main-Switch**

**Descriptions**

The WD3121 is a high efficiency, peak current control mode DC-DC boost converter. It supports up to 1A output current with an integrated low R<sub>DS(ON)</sub> (130mΩ) N-channel MOSFET and cycle by cycle current limit protection. The device provides a USB 5V compliant power output from a single Li-ion battery.

The boost converter runs in Pulse-Width Modulation (PWM) mode, at 1MHz fixed switching frequency to reduce output ripple, improve conversion efficiency. It allows for the use of small external components. At light load currents the converter enters Skipping Mode to maintain a high efficiency over a wide load current range. The build-in soft start circuitry minimizes the inrush current at start-up. Fixed 5V<sup>(\*)</sup> output and internal compensation network require only boost inductor, schottky diode, and input and output capacitors for WD3121, save PCB area.

The WD3121 is available in SOT-23-6L package. Standard product is Pb-free and Halogen-free.

**Features**

- Input voltage range : 2.7~5.5V
- Continuous output current : 1.0A
- Switching frequency : 1MHz (Typ.)
- Efficiency : Up to 92%
- Main switch current limit : 2.75A (Min.)
- Low R<sub>DS(ON)</sub> main switch : 0.13 Ω
- Fixed Output Voltage : 5V<sup>(\*)</sup>
- Output voltage accuracy : ±2%

**Applications**

- MID
- Mobile power pack
- Mobile phones
- Notebook computers
- Portable games



**SOT-23-6L**

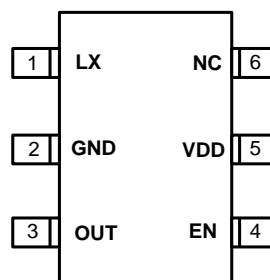

**Pin configuration (Top view)**

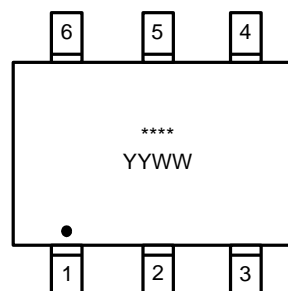

\*\*\*\* = Device code  
 YY = Year code  
 WW = Week code  
**Marking**

Device	Package	Marking	Shipping
WD3121E-6/TR	SOT-23-6L	3121	3000/Reel&Tape
WD3121E51-6/TR	SOT-23-6L	E5V1	3000/Reel&Tape
WD3121E52-6/TR	SOT-23-6L	E5V2	3000/Reel&Tape

**Order information**

**Note:**

- \* : WD3121E fixed 5V Output voltage
- WD3121E51 fixed 5.1V Output voltage
- WD3121E52 fixed 5.2V Output voltage

Typical applications

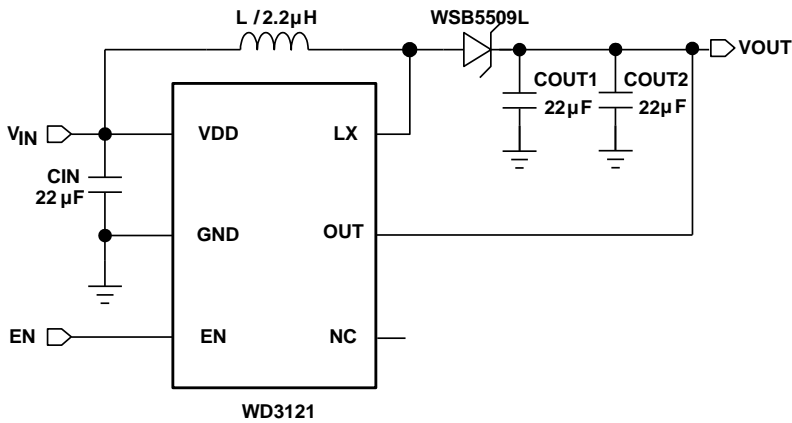

Pin descriptions

Symbol	SOT-23-6L	Descriptions
LX	1	Switch pin
GND	2	Ground
OUT	3	Connect to output
EN	4	Enable, Active High
VDD	5	Power Supply
NC	6	Not connect

Block diagram

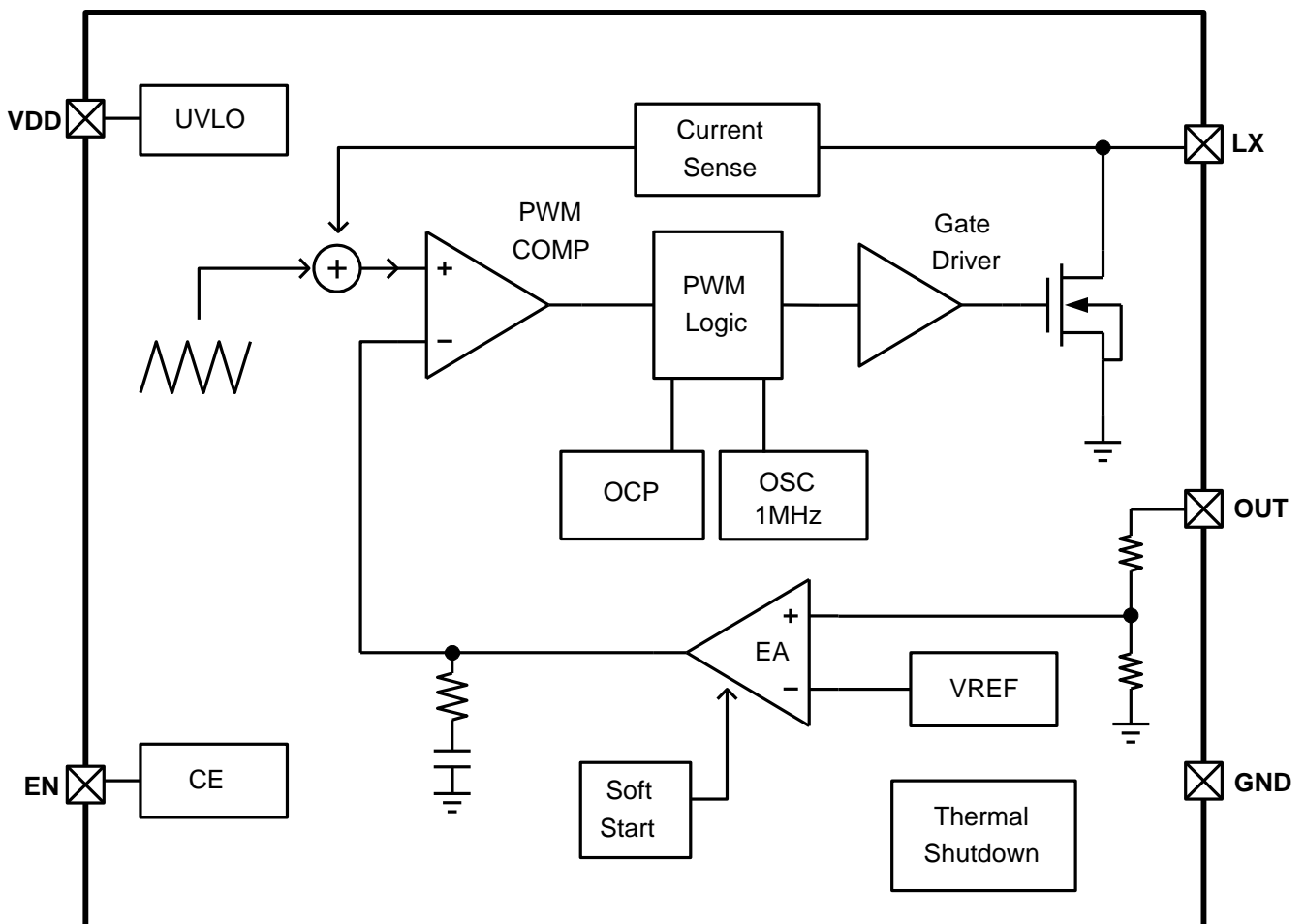

**Absolute maximum ratings**

Parameter	Symbol	Value	Unit
VDD pin voltage range	$V_{DD}$	-0.3~6.5	V
Out pin voltage range	$V_{OUT}$	-0.3~6.5	V
EN pin voltage range	$V_{EN}$	-0.3~ $V_{DD}$	V
LX pin voltage range (DC)	$V_{LX}$	-0.3~ $V_{DD}$	V
Power Dissipation – SOT-23-6L (Note 1)	$P_D$	0.5	W
Power Dissipation – SOT-23-6L (Note 2)		0.3	W
Junction to Ambient Thermal Resistance – SOT-23-6L (Note 1)	$R_{\theta JA}$	250	°C/W
Junction to Ambient Thermal Resistance – SOT-23-6L (Note 2)		416	°C/W
Junction temperature	$T_J$	150	°C
Lead temperature(Soldering, 10s)	$T_L$	260	°C
Operation temperature	$T_{opr}$	-40 ~ 85	°C
Storage temperature	$T_{stg}$	-55 ~ 150	°C
ESD Ratings	HBM	8000	V
	MM	400	V

These are stress ratings only. Stresses exceeding the range specified under “Absolute Maximum Ratings” may cause substantial damage to the device. Functional operation of this device at other conditions beyond those listed in the specification is not implied and prolonged exposure to extreme conditions may affect device reliability.

**Note 1:** Surface mounted on FR-4 Board using 1 square inch pad size, dual side, 1oz copper

**Note 2:** Surface mounted on FR-4 board using minimum pad size, 1oz copper

**Electronics Characteristics** ( $T_a=25^{\circ}\text{C}$ ,  $V_{\text{IN}}=3.7\text{V}$ ,  $V_{\text{EN}}=V_{\text{IN}}$ , unless otherwise noted)

Parameter	Symbol	Test Condition	Min	Typ	Max	Units	
Operation Voltage Range	$V_{\text{DD}}$		2.7	--	5.5	V	
Under Voltage Lockout	$V_{\text{UVLO}}$	$V_{\text{IN}}$ Rising	1.8	2.2	2.5	V	
UVLO Hysteresis	$V_{\text{UVLO-HYS}}$			0.1		V	
Quiescent Current	$I_{\text{Q}}$	$V_{\text{OUT}} = 5.5\text{V}$		0.3	1	mA	
Supply Current	$I_{\text{S}}$	$V_{\text{OUT}} = 4.5\text{V}$		1	2	mA	
Shutdown Current	$I_{\text{SD}}$	$V_{\text{EN}} < 0.4\text{V}$			1	$\mu\text{A}$	
Operation Frequency	$f_{\text{OSC}}$		0.8	1	1.2	MHz	
Maximum Duty Cycle	$D_{\text{MAX}}$		85			%	
Output Voltage	WD3121E	$V_{\text{OUT}}$	$I_{\text{LOAD}}=100\text{mA}$	4.9	5	5.1	V
	WD3121E51	$V_{\text{OUT}}$	$I_{\text{LOAD}}=100\text{mA}$	5	5.1	5.2	V
	WD3121E52	$V_{\text{OUT}}$	$I_{\text{LOAD}}=100\text{mA}$	5.1	5.2	5.3	V
Main Switch MOS on-resistance	$R_{\text{ON,S}}$	$I_{\text{LX}}=100\text{mA}$		0.13		$\Omega$	
Main Switch Current Limit	$I_{\text{LIM}}$		2.75	4.2		A	
Shutdown Voltage	$V_{\text{ENL}}$				0.4	V	
Enable Voltage	$V_{\text{ENH}}$		1.5			V	
EN Sink Current	$I_{\text{EN}}$			3		$\mu\text{A}$	
Thermal Shutdown Temperature	$T_{\text{SD}}$			160		$^{\circ}\text{C}$	
$T_{\text{SD}}$ Hysteresis	$T_{\text{SD-HYS}}$			30		$^{\circ}\text{C}$	

**Typical Characteristics** ( $T_a=25^{\circ}\text{C}$ ,  $V_{IN}=3.7\text{V}$ ,  $V_{EN}=V_{IN}$ , unless otherwise noted)

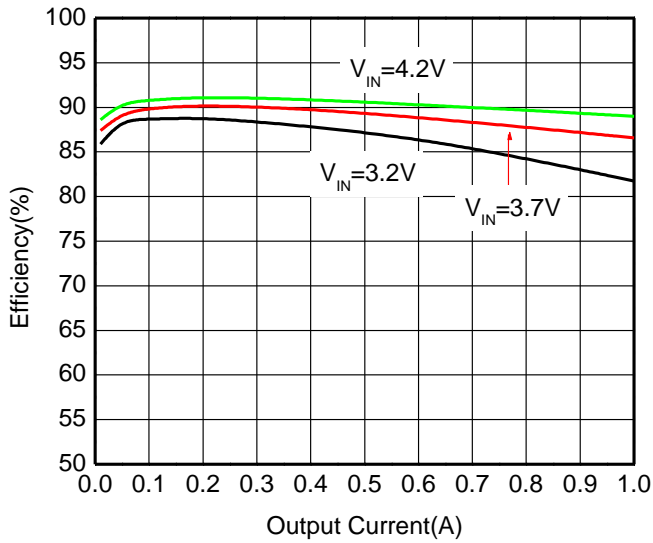

**Efficiency vs. Output Current**

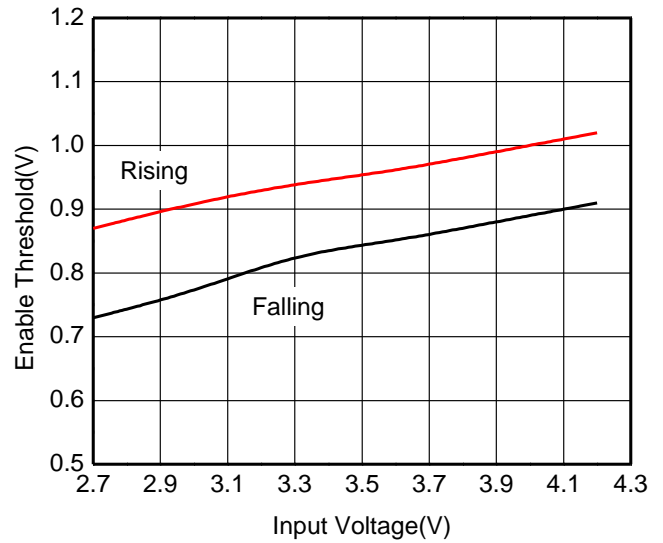

**EN Threshold Voltage vs. Input Voltage**

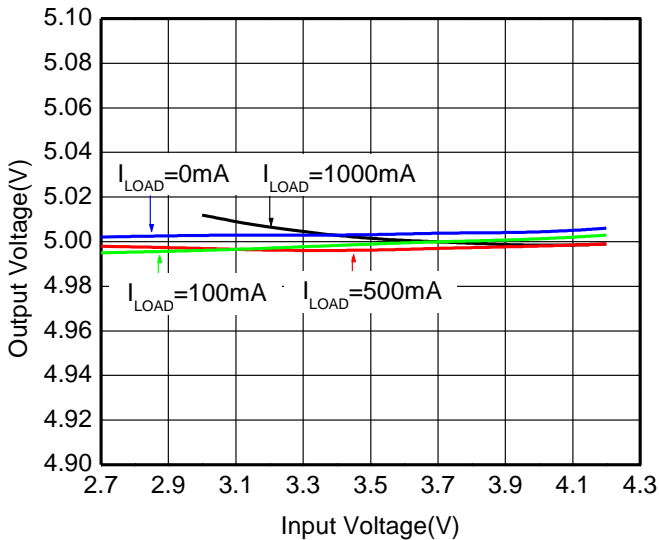

**Output Voltage vs. Input Voltage**

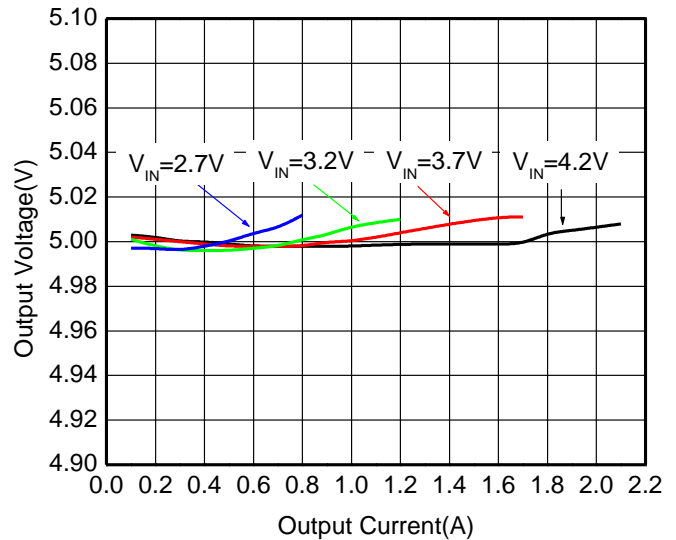

**Output Voltage vs. Output Current**

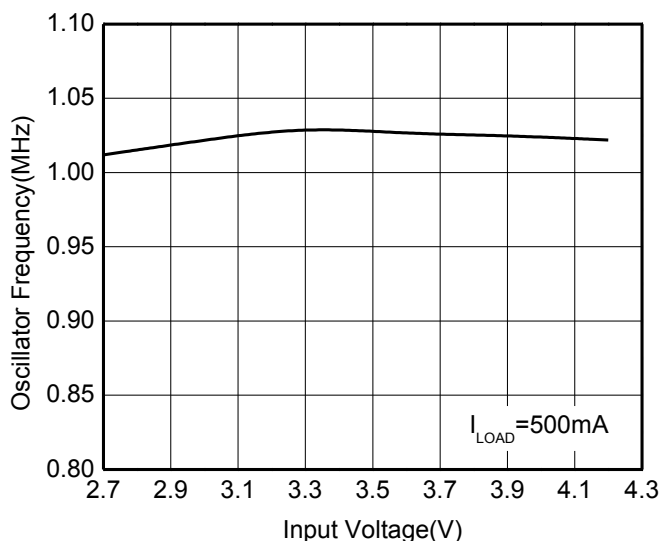

**Frequency vs. Input Voltage**

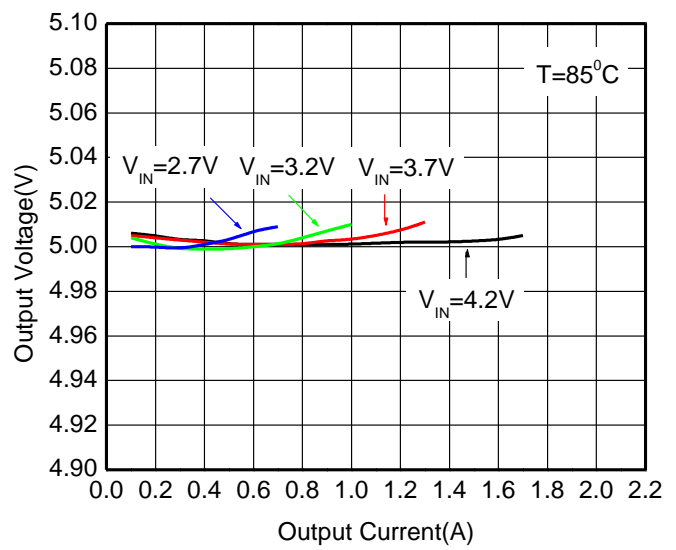

**Output Voltage vs. Output Current**

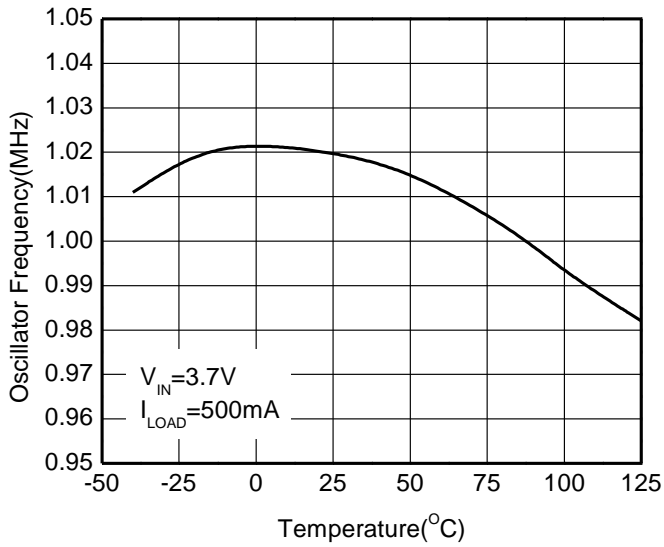

Oscillator Frequency vs. Temperature

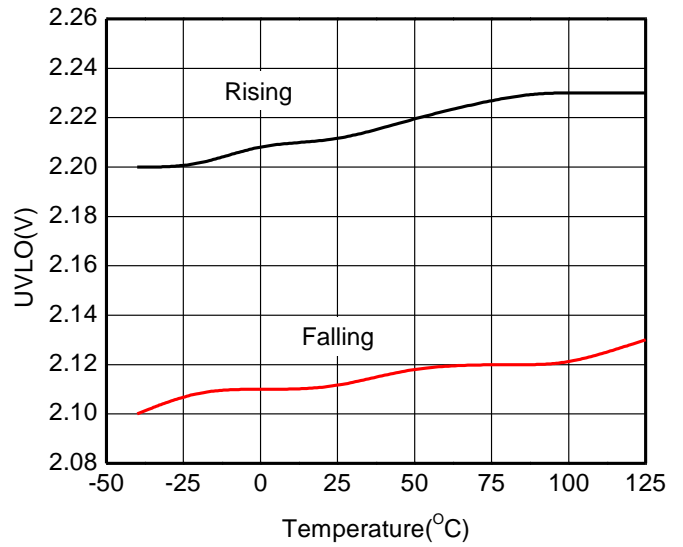

UVLO vs. Temperature

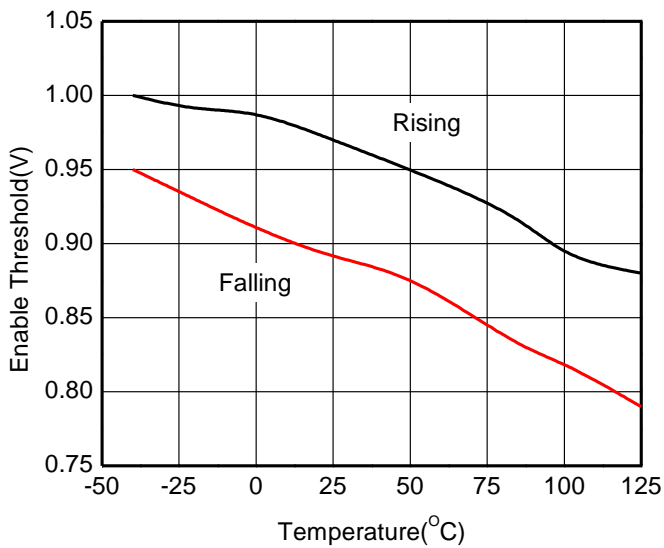

Enable Threshold Voltage vs. Temperature

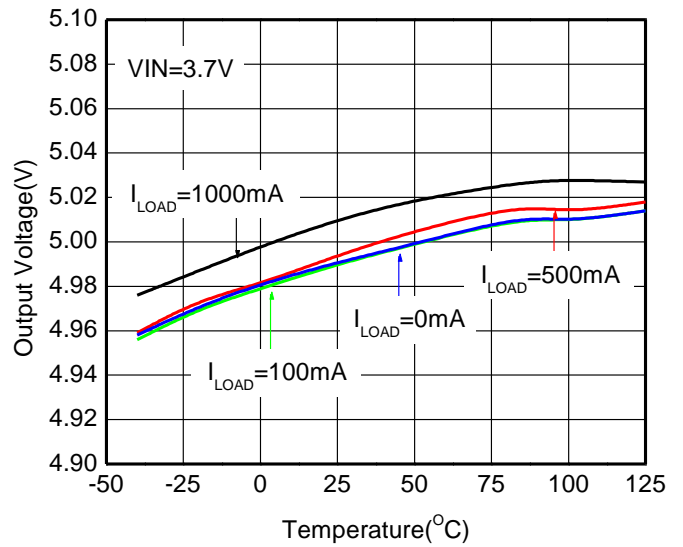

Output Voltage vs. Temperature

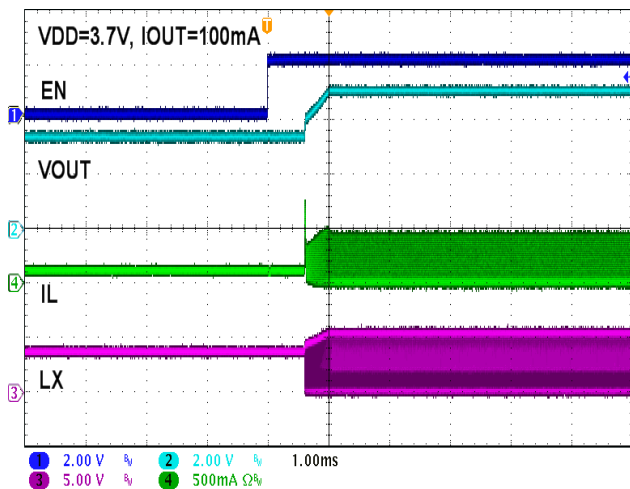

Start-up from EN

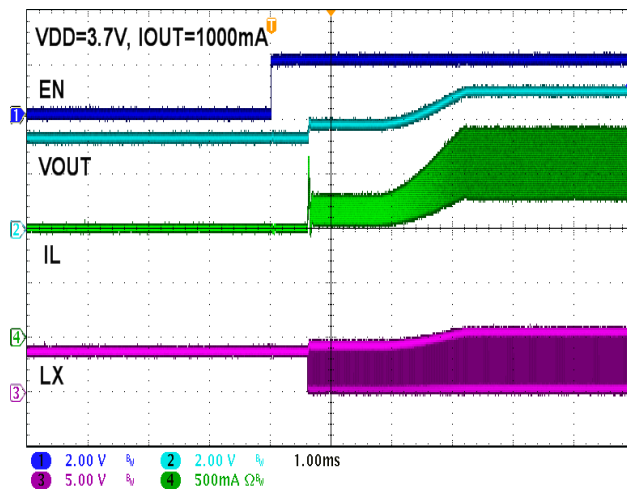

Start-up from EN

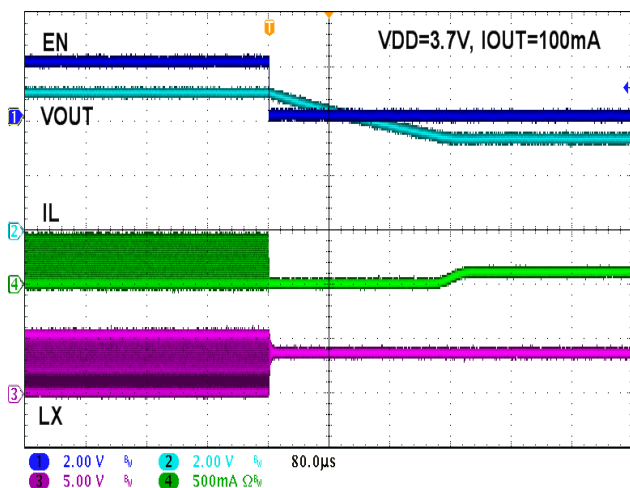

Shutdown from EN

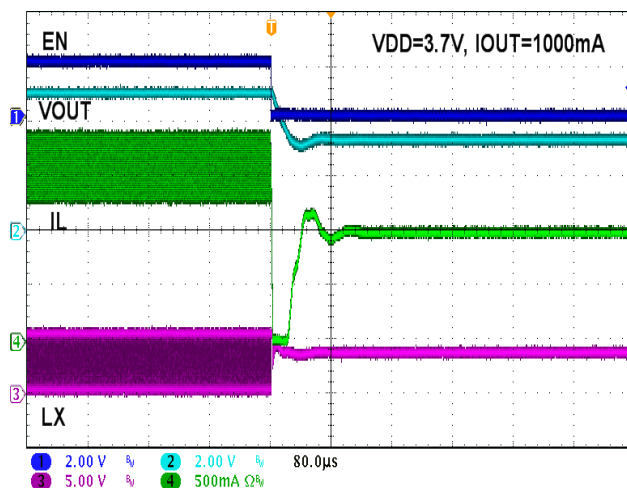

Shutdown from EN

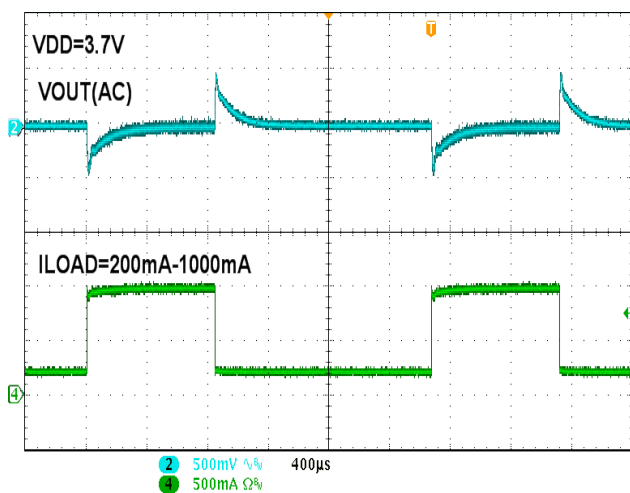

Load Step

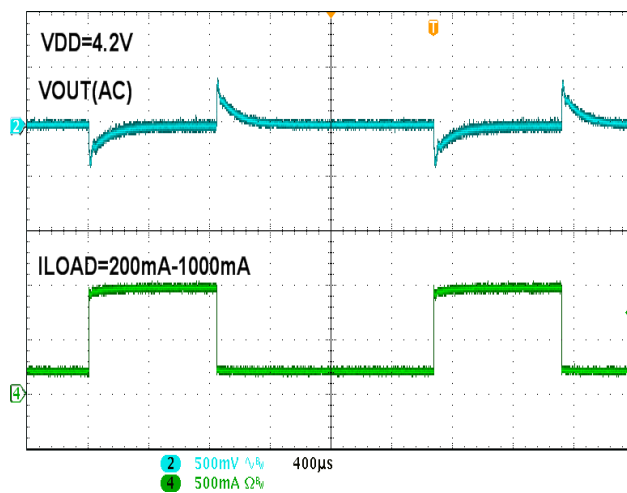

Load Step

## Operation Information

### Normal Operation

The WD3121 is a fixed 5V<sup>(\*)</sup> output, peak current controlled DC-DC boost converter. This means that switch duty cycle is directly controlled by the peak switch current rather than only by output voltage.

The WD3121 regulates the output voltage using a combined pulse-width (PWM) and pulse-skipping (PSM) modulation topology. In PWM mode, the device runs at a 1MHz fixed frequency. Referring to the block diagram, the switch is turned ON at the start of each oscillator cycle. It is turned OFF when switch current reaches a predetermined level. The current trip level is set by using an error amplifier which senses the converter output voltage. The main switch current sensing voltage signal is summed by a slope compensation voltage signal. Slope compensation is necessary to prevent sub-harmonic oscillations that may occur in peak current mode architectures when exceeding 50% duty cycle. At very light loads, the WD3121 will automatically enter pulse skipping mode (PSM). When the converter output voltage is slightly higher than 5V, the device will stop switching and skip some periods to maintain output regulation.

The WD3121 is highly integrated with a low on-resistance N-MOS switch, internal control-loop compensation network and soft-start circuitry. Additional features include Cycle-By-Cycle Current Limit Protection, Under Voltage Protection and Over Temperature Protection.

### Start-Up

The build-in soft-start function of WD3121 is implemented to suppress the inrush current to an acceptable value at the beginning of power on.

### Cycle by Cycle Current Limit

The WD3121 uses a cycle-by-cycle current limit circuitry to limit the inductor peak current in the event of an overload condition. The current flow

through inductor in charging phase is detected by a current sensing circuit. As the value comes across the current limiting threshold the N- MOSFET turns off, so that the inductor will be forced to leave charging stage and enter discharging stage. Therefore, the inductor current will not increase over the current limiting threshold.

### UVLO Protection

To avoid malfunction of the WD3121 at low input voltages, an under voltage lockout is included that disables the device, until the input voltage exceeds 2.2V (Typ.).

### Shutdown Mode

Drive EN to GND to place the WD3121 in shutdown mode. In shutdown mode, the reference, control circuit, and the main switch turn off. Input current falls to smaller than 1µA during shutdown mode.

### Over Temperature Protection (OTP)

As soon as the junction temperature ( $T_J$ ) exceeds 160°C (Typ.), the WD3121 goes into thermal shutdown. In this mode, the main N-MOSFET is turned off until temperature falls below typically 130°C. Then the device starts switching again.

### Note:

- \* : WD3121E fixed 5V Output voltage
- WD3121E51 fixed 5.1V Output voltage
- WD3121E52 fixed 5.2V Output voltage



## Application Information

External component selection for the application circuit depends on the load current requirements. Certain tradeoffs between different performance parameters can also be made.

### Boost Inductor Selection

A 2.2uH inductor is recommended to connect from VDD to LX. The minimum and maximum inductor values are constrained by many considerations. The minimum inductance is limited by the peak inductor-current value. The ripple current in the inductor is inversely proportional to the inductance value, so the output voltage may fall out of regulation if the peak inductor current exceeds the current-limit value (2.75A minimum). Using a nominal 2.2uH inductor allows full recommended current operation even if the inductance is 20% low (1.76 uH) due to component variation. A maximum 4.7uH (typical) inductor value is recommended to maintain adequate phase margin over the full range of recommended operating conditions.

The saturation current of inductor should be higher enough than the peak switch current. And the inductor should have low core losses at 1MHz and low DCR (copper wire resistance).

### Input Capacitor Selection

Connect the input capacitance from VDD to the reference ground plane. Input capacitance reduces the ac voltage ripple on the input rail by providing a low-impedance path for the switching current of the boost converter. The WD3121 does not have a minimum or maximum input capacitance requirement for operation, but a 22uF, X7R or X5R ceramic capacitor is recommended for most applications for reasonable input-voltage ripple performance. There are several scenarios where it is recommended to use additional input capacitance.

### Output Capacitor Selection

Connect the boost-converter output capacitance

from Output to the reference ground plane. The Output capacitance controls the ripple voltage on the Output rail and provides a low-impedance path for the switching and transient-load currents of the boost converter. It also sets the location of the output pole in the control loop of the boost converter. There are limitations to the minimum and maximum capacitance on Output. The recommended minimum capacitors on Output are two 22uF, X5R or X7R ceramic capacitor. The low ESR of the ceramic capacitor minimizes ripple voltage and power dissipation from the large, pulsating currents of the boost converter and provides adequate phase margin across all recommended operating conditions.

### Diode Selection

The rectifier diode supplies current path to the inductor when the internal MOSFET is off. Use a schottky with low forward voltage to reduce losses. The diode should be rated for a reverse blocking voltage greater than the output voltage used. The average current rating must be greater than the maximum load current expected, and the peak current rating must be greater than the peak inductor current.

Diode the following requirements:

- Low forward voltage
- High switching speed : 50ns max.
- Reverse voltage : VOUT + VF or more
- Rated current : IPK or more

Diode Example:

Device	Package
WSB5509L	SOD-123FL

### PCB Layout Considerations

A good circuit board layout aids in extracting the most performance from the WD3121. Poor circuit layout degrades the output ripple and the electromagnetic interference (EMI) or electromagnetic compatibility (EMC) performance. The evaluation board layout is optimized for the WD3121. Use this layout for best performance. If this layout needs changing, use the following guidelines:

1. Use separate analog and power ground planes. Connect the sensitive analog circuitry (such as voltage divider components) to analog ground; connect the power components (such as input and output bypass capacitors) to power ground. Connect the two ground planes together near the load to reduce the effects of voltage dropped on circuit board traces. Locate  $C_{IN}$  as close to the  $V_{DD}$  pin as possible, and use separate input bypass capacitors for the analog.
2. Route the high current path from  $C_{IN}$ , through  $L$  to the  $LX$  and  $GND$  pins as short as possible.
3. Keep high current traces as short and as wide as possible.
4. The output filter of the boost converter is also critical for layout. The Diode and Output capacitors should be placed to minimize the area of current loop through Output – $GND$ – $LX$ .
5. Avoid routing high impedance traces, such as Output, near the high current traces and components or near the Diode node (D).
6. If high impedance traces are routed near high current and/or the  $LX$  node, place a ground plane shield between the traces.

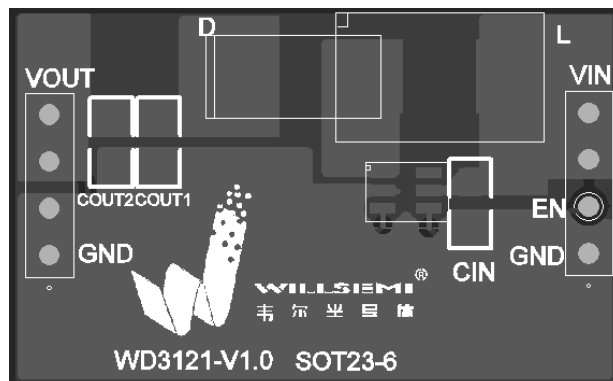

WD3121 Demo Board Layout (Top)



WD3121 Demo Board Layout (Bottom)

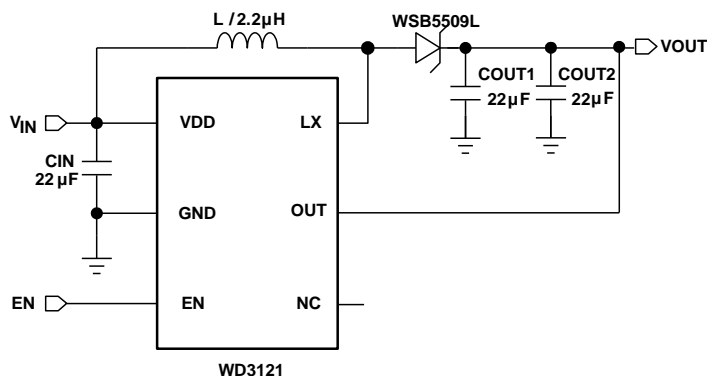

WD3121 Demo Board Schematic

Package outline dimensions

SOT-23-6L

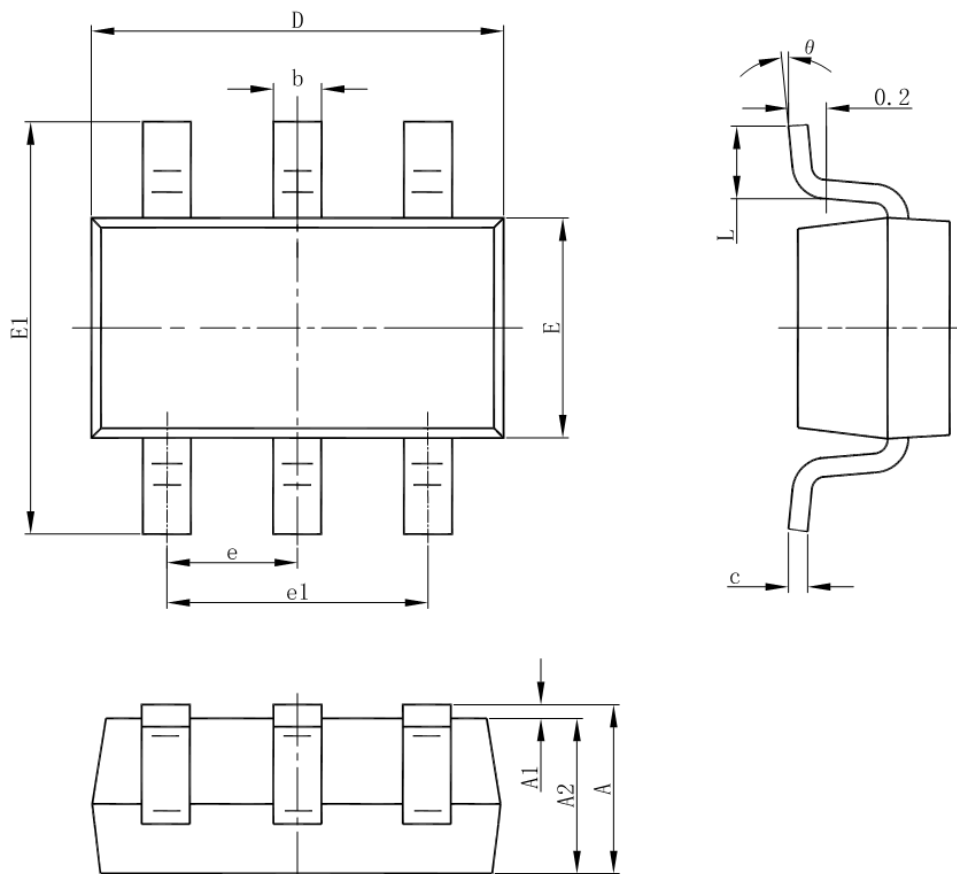

Symbol	Dimensions in millimeter		
	Min.	Typ.	Max.
A	1.050	-	1.250
A1	0.000	-	0.100
A2	1.050	-	1.150
b	0.300	-	0.500
c	0.100	-	0.200
D	2.820	2.900	3.020
E	1.500	1.600	1.700
E1	2.650	2.800	2.950
e	0.950(BSC)		
e1	1.800	-	2.000
L	0.300	-	0.600
θ	0°	-	8°